

# WE OFFER EXPERIENCE, IDEAS, KNOWLEDGE & ENTHUSIASM

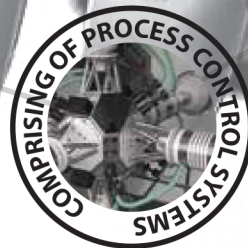

POWER AUTOMATION SOLUTIONS (Pvt) LTD



**OPTIMIZING  
AUTOMATION  
SOLUTIONS**



# TABLE OF CONTENT

---

---

Vision / Mission	2
About Us	3
Total Engineering Solutions	4
Engineering Management & Designing	6
Integrated Control Systems Solutions	8
Instrumentation & Controls	10
Installations, Supervision & Commissioning	12
Plant Startups & Operation Support Services	14
On Call Site Supports & Troubleshooting Services	16
Maintenance Services & Contracts	18
System Specific Trainings Facilities	20
Parts, Instruments & Components Supply	22
Decommissioning, Dismantling & Migration Services	24
Oil & Gas Industry	26
Automotive Industry	28
Entertainment Industry	30
Life Sciences – (Food, Beverage & Consumer Products)	32
Life Sciences – (Pharmaceutical & Specialty Chemicals)	34
Water & Waste Industry	36
Mining, Cement & Material Handling Industry	38
Our Shared Values With	40

---

# VISION

---

**PASOL** envisions to be the number one system automation company providing specialized and optimized automation solutions globally to all industries ranging from power, textile, oil & gas sectors, cement, sugar, packaging, paper, pulp and fertilizers. We wish to extend and maintain our relationship with new and existing clients with a standard of complete professionalism and define the term "value for money" in literal terms for them.

# MISSION

---

*"To empower our clients to capture maximum value from their industrial assets through intelligent automation products, solutions and services efficiently delivered worldwide."*







# ABOUT US

**PASOL** Technologies is a system automation company providing specialized & optimized automation solutions globally to all Industries. We provide our expertise in the following industrial sectors: Cement, Sugar, Packaging, Paper & Pulp, Fertilizers, Power, Textiles, and Petrochemicals.

We are a total engineering solutions provider company, with our entire focus on empowering our customers to gain maximum value from their Industries by effectively utilizing our services through the use of multiple automation products of renowned OEMs which are recognized internationally. Our team of dedicated engineers are always there to assist you in your need and provide you with a solution that suits your industrial requirements.

Our moto is to meet your expectation to full extent with target of exceeding your expectations at all tasks in hand. We have a very loyal group of people who take pride in their work and enjoy that sense of accomplishment in knowing they have another satisfied customer. As in any team sport the word "chemistry" is often used to describe the success of that team. We too, believe that we have "team chemistry" which has helped us build long standing relationships with our customers and vendors.

We offer experience, ideas, knowledge, enthusiasm, a little humor; plus WE ALL CARE.





▶ TOTAL ENGINEERING SOLUTIONS







## ***"A COMPLETE ENGINEERING SOLUTION AVAILABLE AT ONE PLACE"***

Total Engineering Solutions contain innovation, cost-effectiveness and on-time services which are essential to industrial manufacturers in the modern age and behind this approach is a driven force for PASOL to structure advisable capabilities that are beyond customers' expectations. PASOL provides precision modeling services as a complete design engineering solution to satisfy customer's ever-changing needs through customizing components. In a business setting, turnkey projects are generally produced by the team of contractors and project leaders who have the complete expertise.

With our engineering and automation knowledge base developed through project completed across the globe; we can help industries in understanding which systems & solutions are best suitable.



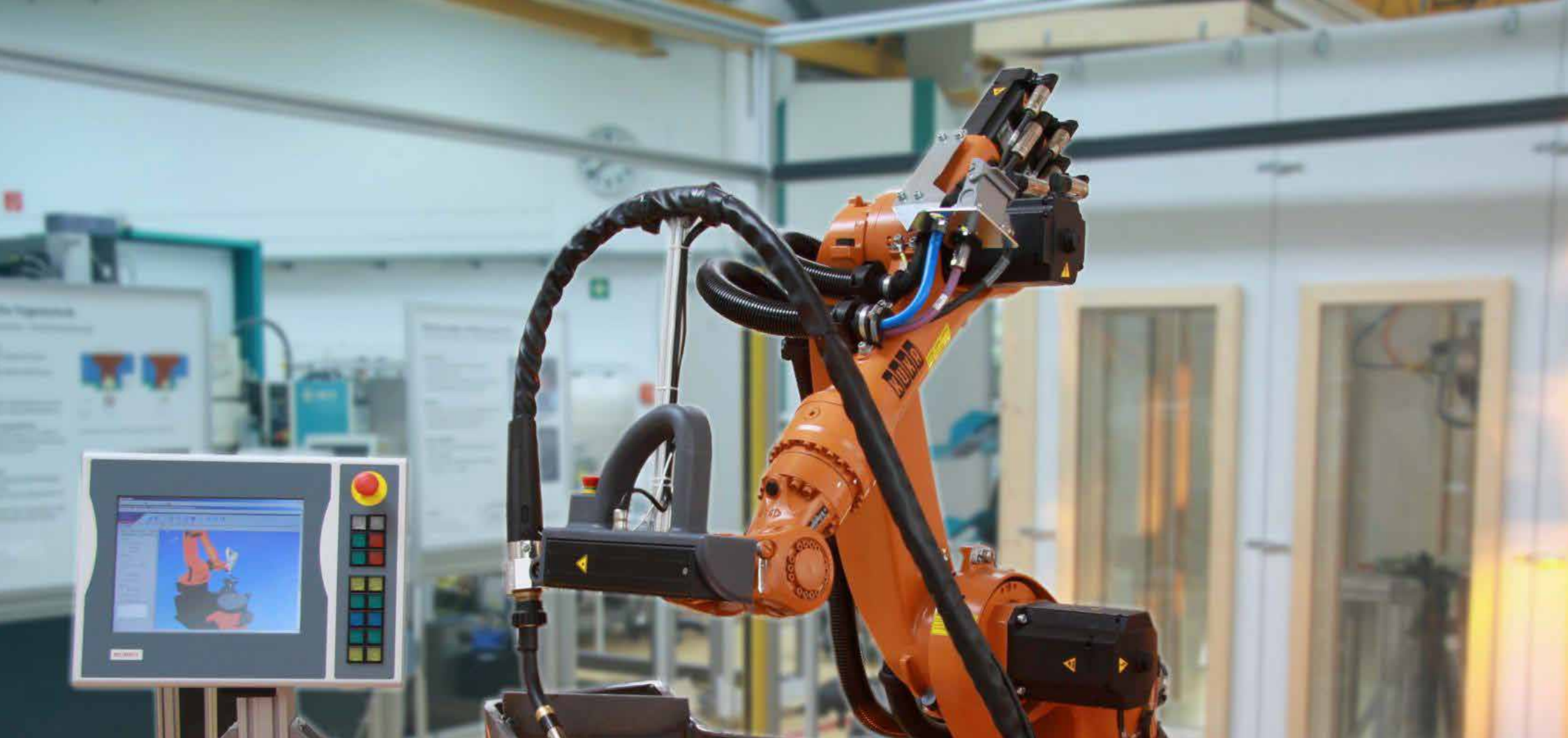

▶ ENGINEERING MANAGEMENT & DESIGNING







## ***“PROVIDING THE BEST AND ERROR FREE ENGINEERING DESIGNING SUITABLE TO YOUR NEEDS”***

Designing control systems that would yield optimal operational performance is a challenge for many industries. Most managers in the industrial sector find it difficult to design systems for upgrade or new installations; if legacy systems or practices involve more than one vendor. Leveraging our multi-vendor expertise & project experience in industrial sector, PASOL provides control system engineering & design services for your automation projects. We help project managers foresee and address design related issues that will arise during the execution stage of the project.

With our experience, we can help in identifying the right systems that will fit in with the existing systems while keeping plant efficiency at its maximum. We will also help in conducting FEED studies identifying system deficiencies and steps to eliminate them while keeping within the resources. Our involvement with multiple systems and vendors over the years has developed the ideal skill required for system management & designing. We at PASOL aim in providing the best fit design to its customers based upon a particular need of its client while at the same time complying with the global & corporate industrial standards.





▶ INTEGRATED CONTROL SYSTEMS SOLUTIONS







## ***“INTEGRATING AND IMPLEMENTING COMPLETE LINKS BETWEEN SOFTWARE AND HARDWARE NETWORKS”***

We specialize in developing integrated control systems with computer software packages that are designed to give operators a view into their entire control and monitoring system through using both standard off-the-shelf products as well as custom solutions when needed. Our trained personnel are experienced in programming many of the leading software products in this market. Computer HMI systems allow users to gain critical information about their process with real-time monitoring, graphical trending, alarming and report generation.

Our integrated control systems solution comprises mainly of Process Control Systems (PCS), from PLC based renowned control systems to DCS based complex systems. This also includes Safety Instrumented Systems (SIS), Fire & Gas Systems (F&G) solutions as well as industrial data networks, communication systems and security systems comprising of CCTV & Anti Intrusion Systems (AIS). We also provide SCADA solutions including HMI and operator interfaces & annunciation as per client needs & demand.





▶ INSTRUMENTATION & CONTROLS DIVISION



## ***“PROVIDING THE RIGHT CONTROLS AND COMMANDS FOR THE RIGHT MACHINERY”***

Plant instrumentation is the eyes and ears of plant operators. Industrial companies are most apprehensive about the integration and startup of instrumentation systems as it is the most critical stage of the project. Major integration issues arise at this stage of project execution as multiple systems are being integrated. Understanding these concerns of plant operators and leveraging on our long-term engineering man-years of experience PASOL offers instrumentation startup and commissioning services.

PASOL Technologies Instrumentation Services assist customers in the Identification of right instrumentation for the plant of recognized OEMs that not only suits the specific area requirement but also improves the overall operational life of the plant.

Based upon a specific requirement from the end user, we deal in Instrumentation package supply as well as also offer instrumentation startup & commissioning services to our clients.





▶ **INSTALLATION, SUPERVISION & COMMISSIONING**







***“WE PLAN AND EXECUTE A COMPLETE LAYOUT FROM INCEPTION TO THE END PRODUCT OF OUR INDUSTRIAL SERVICES”***

PASOL along with engineers of the equipment being supplied carry out managerial and engineering supervision over performance of works by the customer’s specialists. The team is focused to fulfill specific requirements and conditions during assembly, initial startup, diagnostics of complex equipment, reaching operational parameters and other works to prepare the equipment for operation. Our expertise developed while working with different systems enables us to foresee any issues that may arise at the time of commissioning keeping the timeline track. Our capabilities allow for smooth integration of instrumentation systems and a hassle-free project completion.

PASOL automation solutions ensure the complete project supervision from the inception to completion with a list of expert, consulting, and technical services. New installations are completely kept in check to ensure that no query arises during and after the completion of a project. The installation supervision and commissioning services offered by PASOL ensure complete reliability of the client’s investment as we keep the warranty obligations for the supplied equipment and minimizes the risk of damaging expensive equipment during installation works.





▶ PLANT STARTUPS & OPERATION SUPPORT SERVICES





***“WE OPERATE AS A FINELY TUNED TEAM TO ENSURE A SYSTEMIZED STARTUP OF INDUSTRIAL PLANTS DESIGNED TO SUIT THE NEED OF OUR CLIENTS”***

With multi-vendor systems and products installed at their facilities industrial companies find it difficult to find partners with the right set of expertise to assist in the Plant Startup & Operation Support Services. At PASOL we provide the launch and startups of industries & offer operational support service. The extremely competent disaster management at PASOL regularly updates safety precautions and reports documentation regularly.





▶ ON CALL SITE SUPPORTS & TROUBLESHOOTING SERVICES



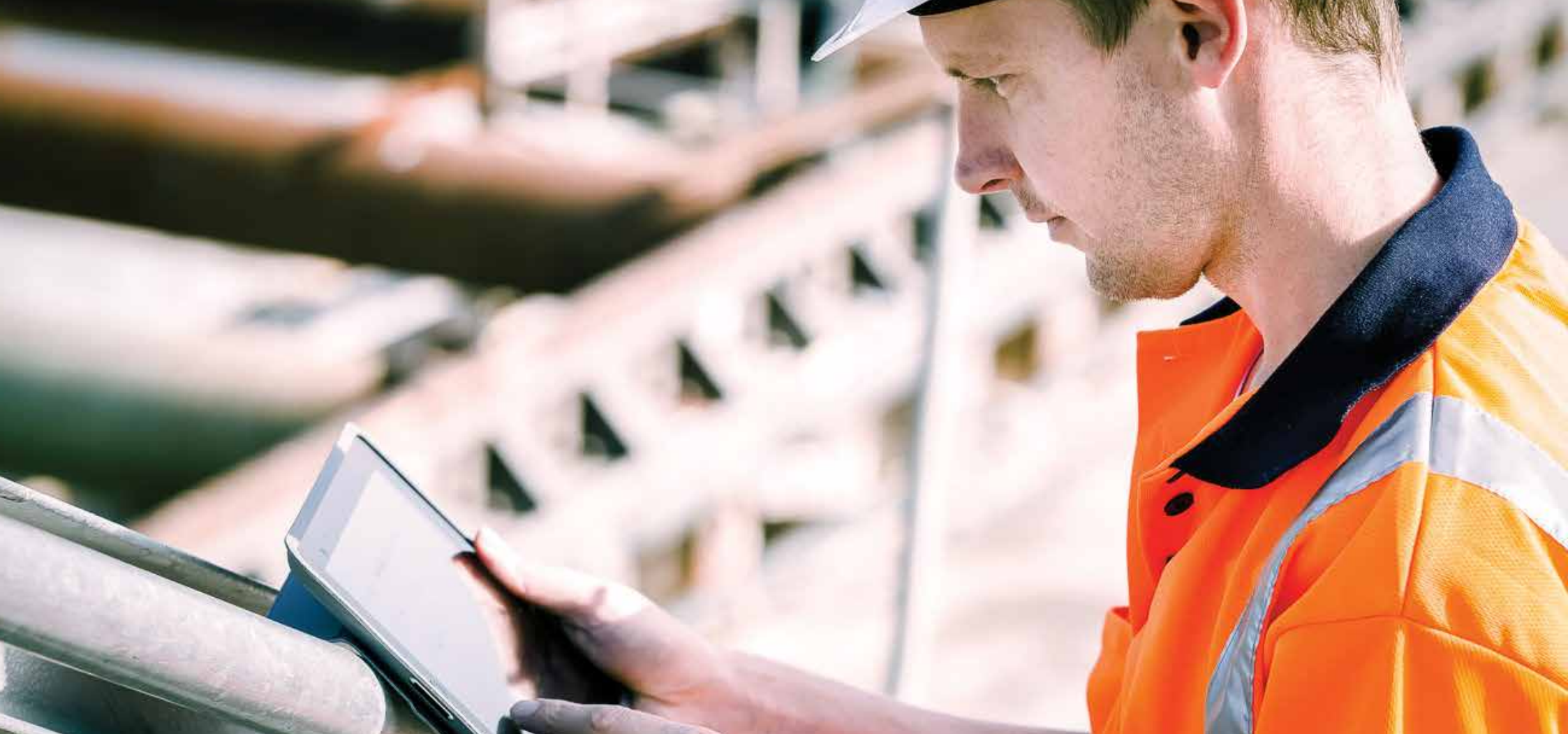

***“WE OFFER MANAGEMENT AND MECHANIZED SUPPORT FOR ALL INDUSTRIAL QUERIES OF OUR CLIENTS”***

PASOL resident/on site O&M services are designed to provide scalable, integrated instrumentation, control & electrical automation expertise during the industrial facility’s asset lifecycles. PASOL resident/on site O&M solution is engineered to meet your unique needs pertaining to multi-vendor equipment, planning & execution of maintenance plans and training of in-house resources.

What makes us stand out from competition is the multi-vendor expertise and industrial specific domain knowledge of our resources; we understand your pain points and performance bottle necks and can work as partners in achieving your business objectives. PASOL is dedicated to provide on call site support & troubleshooting services for the industrial plants in a way that maximized uptime, minimized O&M costs while ensuring safety of plant personal and environment.





▶ MAINTENANCE SERVICES & CONTRACTS





***“WE ARE ALWAYS PREPARED FOR A CHALLENGE AND TACKLE PROBLEMS WITH STEADY PLANNING AND EXECUTION”***

PASOL remote optimization & maintenance services provide a proactive and effective approach towards early diagnosis of problems and optimization of processes when it is not possible for deployment of resources at site. Leveraging our investment in automation labs, we can remotely connect to your automation assets, troubleshoot and assist your operators to solve challenges.

We offer these services when the traditional method of fine tuning system performance and problem resolution might not provide optimal results. With our O&M services, data collection and analysis begin immediately and experts are brought closer to the problems and solutions over remote connections paving the way for smooth technical collaboration and shortened time-to-resolution enabling our clients to maximize cost effectiveness and minimize downtimes. PASOL maintenance services ensure that the best skilled resources are deployed over remote connections within minimum time and enable our client's facilities run on maximum efficiencies regardless of their location on the grid. Our operations & maintenance services include on call O&M services, remote O&M services as well as O&M training solutions. Our target is to be provide long term product maintenance & up-gradation services to our clients as per their needs & demands to increase their overall plant profitability.





▶ SYSTEM SPECIFIC TRAININGS FACILITIES







## ***“WE EDUCATE GENERATIONS TO ENSURE PROFICIENT RESULTS”***

Without proper training, an automation project can never reach its full potential. PASOL is proud to offer training services that our customers have remarked are among the best they have ever experienced. We know that learning by doing is the best way for your personnel to achieve proficiency in the use of a control system.

PASOL provides hands-on, interactive classroom training using actual operator interface terminals and customized simulation logic. This allows “learning by doing” without risk to your equipment or product. The combination of a powerpoint lecture and interactive exercises allows the trainer to convey automation concepts to your staff far better than a lecture or manual ever could. Using simulation logic, the student exercises focus on normal operating procedures, system shutdown and startup, and fault recovery. Targeted training is available for your supervisors, managers, and maintenance technicians. Technician training focuses on manual control of system devices, calibration procedures, and most importantly how to identify equipment problems through the HMI via alarms and status messaging. Manager training focuses on higher level tasks, such as recipe management, inventory tracking, and analyzing production efficiencies and deficiencies through the reporting system.



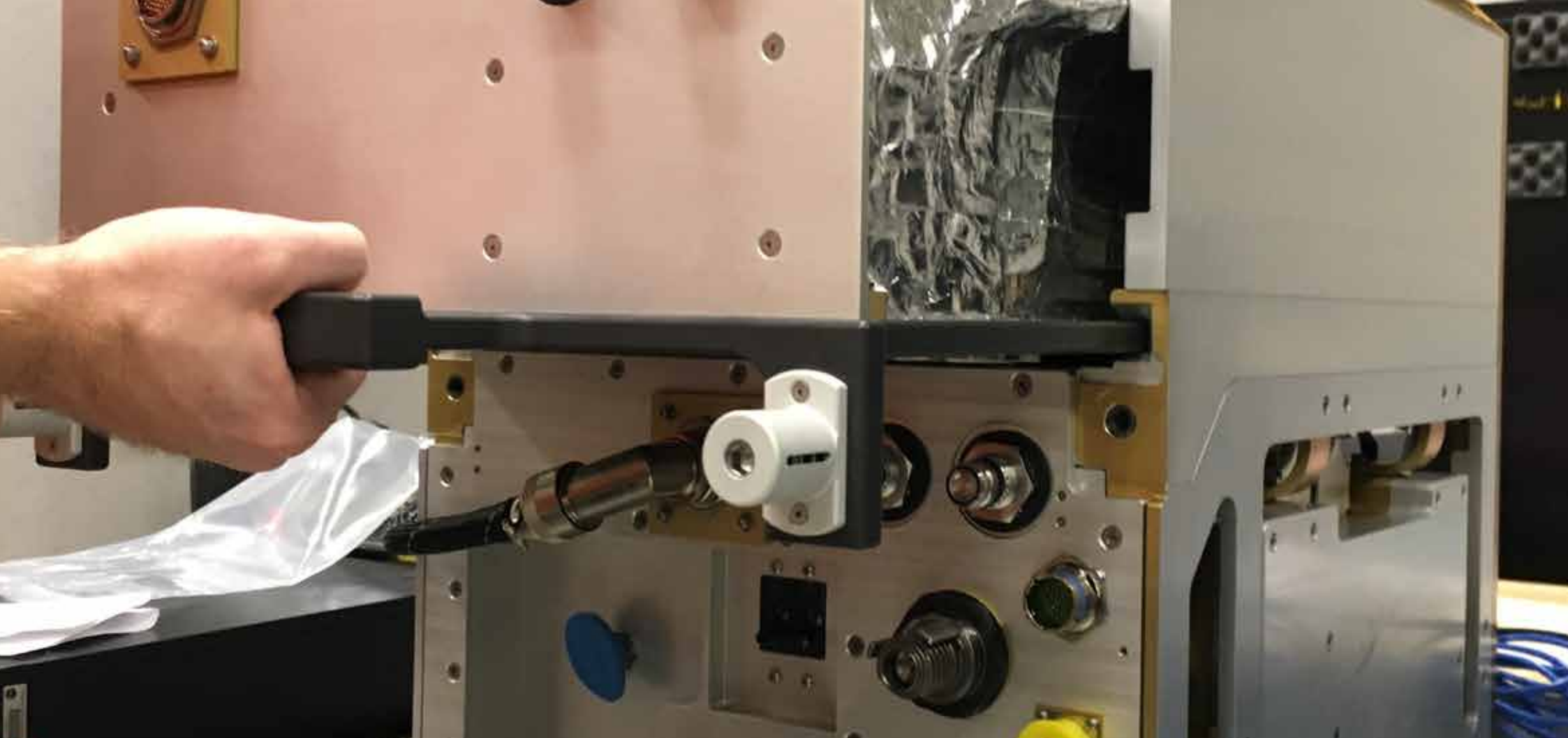

▶ PARTS, INSTRUMENTS & COMPONENTS SUPPLY





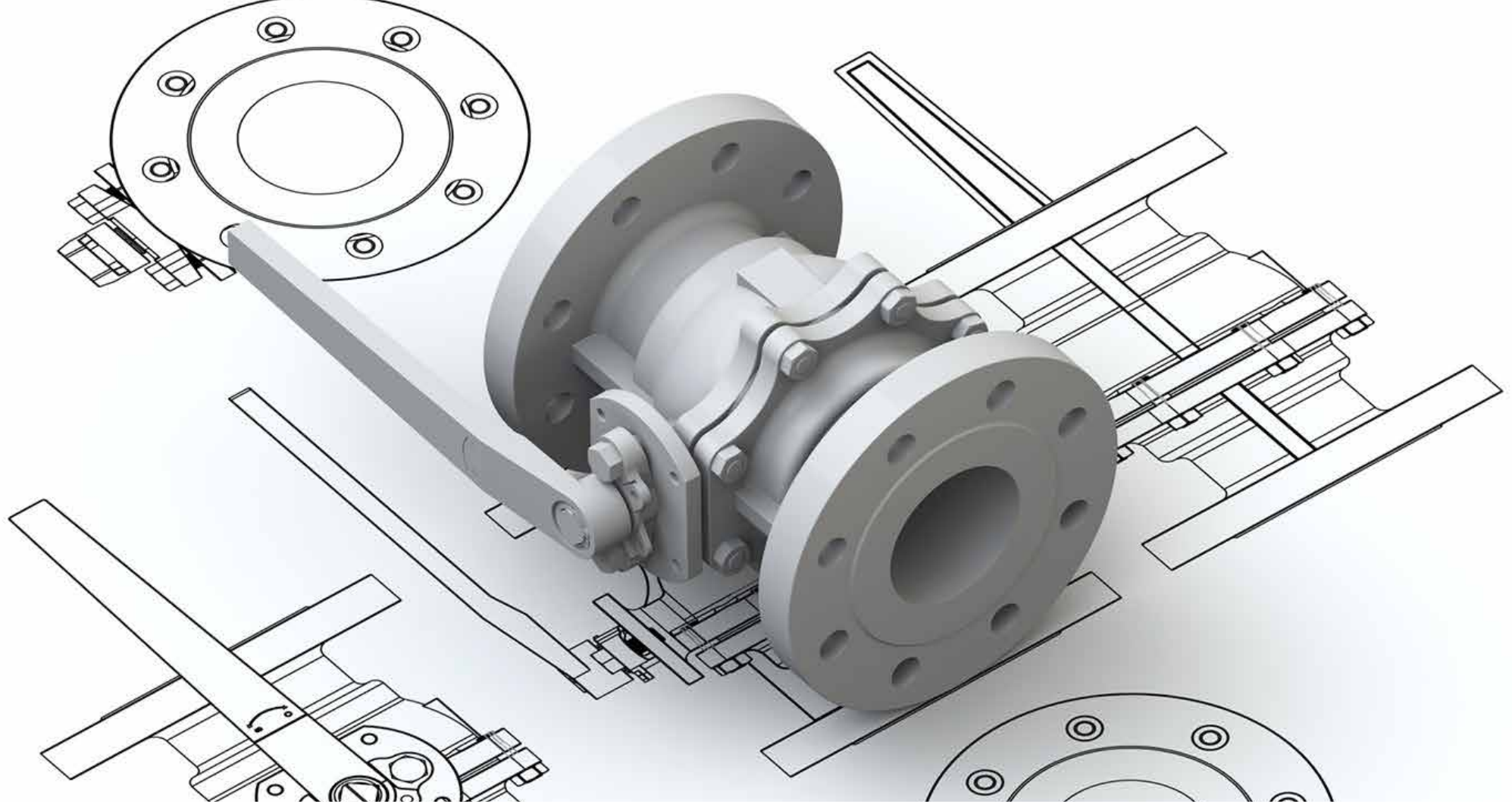

***“WE PROVIDE THE MIDDLE MANAGEMENT OF MACHINERY TO ENSURE MAXIMUM OUTPUT FOR INDUSTRIES”***

A well-oiled machine is a result of well-maintained components and PASOL believes in providing up to date supply of the latest parts, instruments and components of automation devices for industrial units. Around the clock service solution is provided to ensure that all the queries related to internal malfunctioning or system de-optimizations are looked after for our clients. For us the smooth working of a machine ensures maximum output and maintains the perfect balance between initial investment and final result. It is our number one priority to encapsulate the demands that our clients looking for in latest technological and mechanical systems.





▶ DECOMMISSIONING, DISMANTLING & MIGRATION SERVICES







***“WE HAVE GOT YOU COVERED FROM THE INCEPTION TILL THE END”***

Safe and efficient decommissioning is essential in managing the end of the lifecycle of industrial and large scale facilities. As a plant service provider with ensuring overall plant competencies, we at PASOL gained most valuable experience in dismantling management and execution. Our experienced and dedicated staff is available to support our customers in cost-effective execution of their decommissioning, dismantling and migration projects. Prior to such projects PASOL ensures that all safety precautions and proper DE installation plans are laid out to maximize time saving output in all such projects towards migration of plants and facilities to new locations within given time frames.





▶ OIL & GAS INDUSTRY



## ***"WE HAVE THE COMPLETE EXPERTISE TO TURN INVESTMENTS INTO PROFITS"***

PASOL group specializes in oil & gas pipeline control systems. Since we are from Pakistan and have international experience on working on various well known oil and gas refineries, our mainstay is pipeline control systems. Although our integrators have a wide range of controls system back grounds, oil & gas is our home.

- Design and construction of pipeline control systems include:
- Design and build pipeline control system cabinets for interior use, or for exterior use.
- Develop Local HMI PC/touch screens applications for data at a glance.
- Develop all PLC programs
- Configure flow computers
- Upper level SCADA and DCS integration
- Startup support
- Technical support after startup

Our team of dedicated engineers has more than 10 years of experience in oil & gas Sector, with clients located locally as well as abroad.

We have extensively worked with and provided oil & gas automated solutions to major clients pertaining to upstream, midstream and downstream areas. This includes process, safety as well as major fire & gas automated controls solutions.







▶ AUTOMOTIVE INDUSTRY





## ***“WE CAN SUPPORT YOU FROM METALFORMING TO FINAL ASSEMBLY”***

In the automotive production market, technology improvement is vital to increase production and revenue, for that reason, PASOL Technologies can optimize your operation, from system design through maintenance. We can support you from metal forming to final assembly.

- Metal forming - Stamping:
- Press control system: Tandem and Transfer Systems
- Welding Stations
- Power train:
- Robot Integration
- Material Handling/conveyors
- Sub-Assembly & Test Machines
- Body Shop/Paint Shop & Final Assembly:
- Specific Control for Water, HVAC and Pressurized Air
- Tracking Solutions
- Manufacturing Execution System (MES)

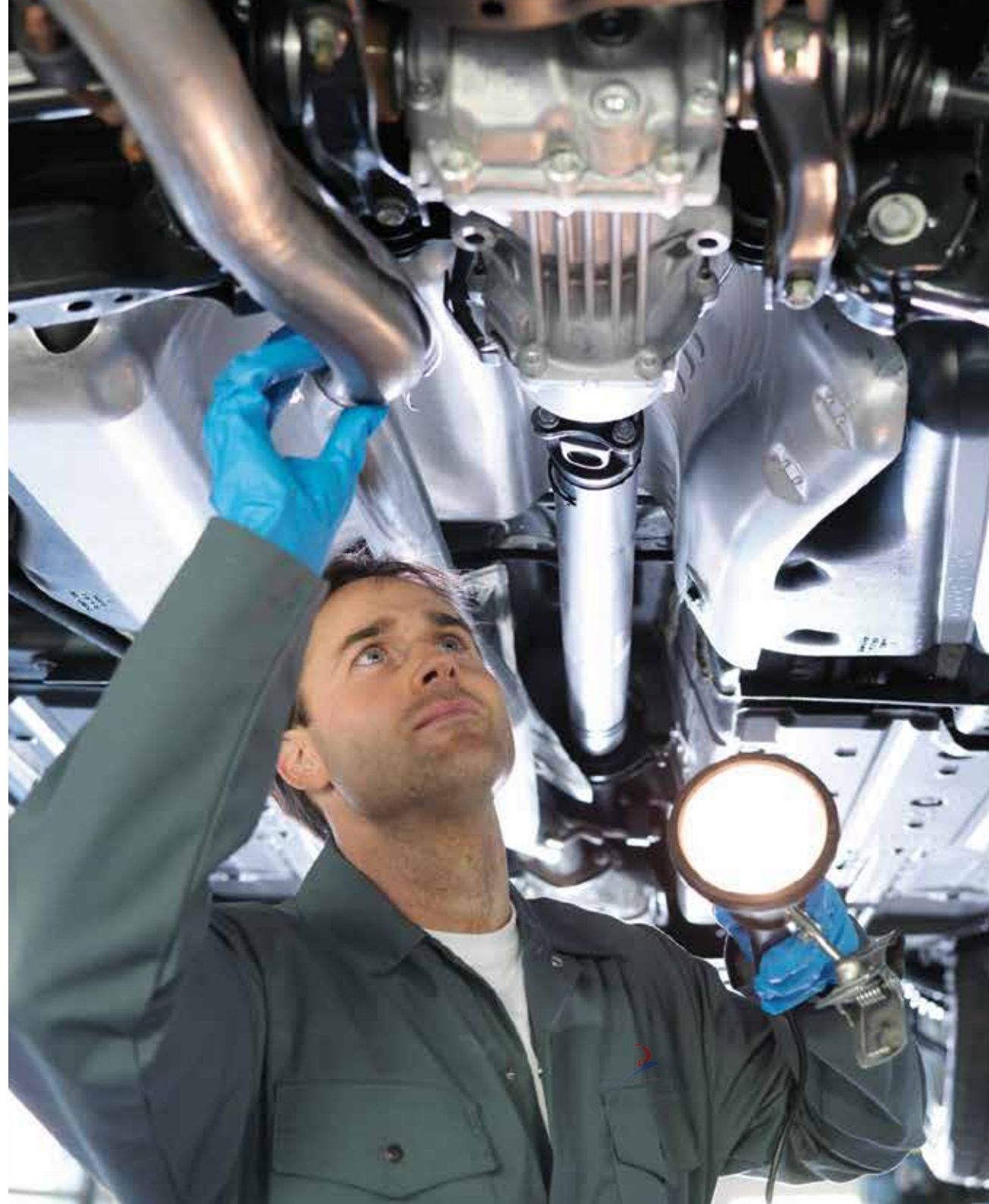





▶ ENTERTAINMENT INDUSTRY





***“WE MAKE SURE THAT WE HAVE THE ESSENTIAL  
FOR THE ENGINEERING AND DESIGN PROCESSES”***

**Theme Park:**

For theme parks, redundancy, instant response times and safety are essential to the engineering and design process.

- Power Distribution
- Motor Control
- Monitoring
- Redundant Controls
- VFD's

**Stage Automation:**

Controlling stage machinery and components through the use of electrical power and automation.

- Motorized equipment
- Stage effects
- Stage lighting







▶ LIFE SCIENCES – (FOOD, BEVERAGE & CONSUMER PRODUCTS)



## ***"WE CAN INCREASE PROFITS AND EFFICIENCY"***

Through the use of automation, we can increase profits and efficiency, optimizing your process with safety in mind.

- Beverages, dairy products, sugar, bread, cakes and pastries, oils and fats, or tobacco.
- Tracking & Tracing
- Automated Conveyor Systems
- Batch systems
- Custom stainless steel control enclosures
- Control & monitoring for refrigeration chambers
- Filling lines







► LIFE SCIENCES – (PHARMACEUTICAL & SPECIALTY CHEMICALS)



## ***“WE CAN HELP YOU TO KEEP PRODUCTION YIELD”***

PASOL Technologies has extensive experience in implementing systems for the life sciences industry. We have helped clients implement batching solutions for liquids, solids, creams and ointments. Solutions have been deployed for tablet manufacturing including granulation, solution preparation and pan coating. PASOL Technologies has also implemented manufacturing execution systems (MES) for lot traceability, genealogy and operational performance. PASOL solutions will enable your company achieve your business goals while meeting the demands of regulatory compliance. Our component based solutions will enable you to control and optimize your manufacturing processes, perform real time data logging and trending and simplify validation.

PASOL Technologies has created a suite of tools and products that enable life science companies achieve that vision. Our tools and products are developed based on the ISA S88 and ISA S95 standards. These standards facilitate our component based strategy which allows us to be very efficient in the delivery cycle. We fully comply with 21 CFR Part II, FDA requirements and follow a GAMP5 life cycle approach.

### **Our Life Sciences Experience include:**

- Functional Specification Development
- FAT/SAT/IOQ protocol Development
- User Manual and SOP Development
- Systems Integration
- HMI/SCADA/PLC Programming/Configuration
- Database Design
- Web Based Reporting
- Training
- Application Experience:
- Batch Systems
- Continuous Systems
- Bioreactor Systems
- Granulation Systems
- Water Systems
- CIP/SIP Systems
- Vision Systems
- Uptime/Downtime Tracking
- OEE (Overall Equipment Effectiveness)

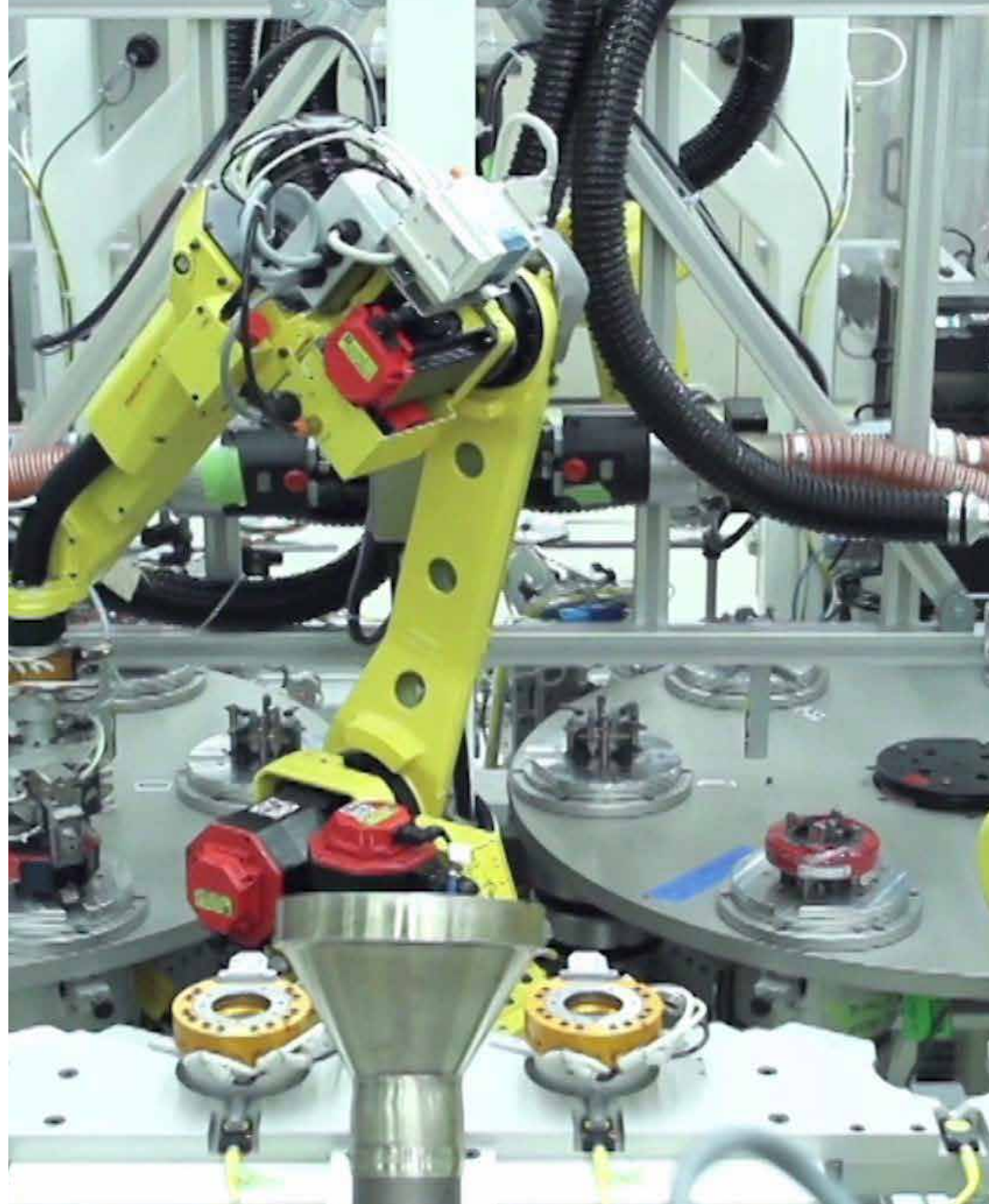







Our Engineering Staff have more than 15 years working in the Water and Waste Water Industry. From the Design, Programming and Start-up of the Automation and Control System for the different process within the industry, we are always ready to come up with a solution that meet our Client's need and demand.

**Clear Water Process:**

**Water Treatment Plants:**

- Filter Control Systems
- Chemical Dosing Process
- Chlorination Process
- Process Monitoring
- SCADA Systems
- Backwash Water Control

**Sedimentation:**

- Sludge Control System

**Water Distribution Systems:**

- Distribution Tanks
- Pressure Booster Pump Stations
- Level Control Pump Stations
- Wireless Telemetry
- Elevated Water Storage Tanks

**Waste Water Process:**

- Aeration
- Sedimentation
- Filter Press System
- Screens System
- Settling Tanks
- SCADA Systems
- Sludge Control System
- Disinfection Process
- Influent Control Pump Station
- Effluent Control Pump Station

**Sewage Systems:**

- Level Control Lift Pump Stations
- Wireless Telemetry

***“WE HAVE OVER 15 YEARS OF EXPERIENCE IN  
THE WATER & WASTE INDUSTRY”***







▶ MINING, CEMENT & MATERIAL HANDLING INDUSTRY





## ***“WE HELP TO DEFINE THE REQUIREMENTS OF EACH PROJECT”***

In PASOL Group we can extract more value at every stage. In the heavy industry operation is the most important, for that reason, our professional and experienced staff works closely with you in defining the requirements of each project so that the equipment we propose meets your needs in all aspects.

### **Sand Silos:**

- Level control
- Filled process control
- Dispatch process control
- Real time monitoring

### **Mining & Cement:**

- E-Houses
- Process instrumentation
- Quarry, Crushing, Pre-Heater and Kiln, Raw Mill Blending and Grinding rolls
- Filtration control
- Low/Medium voltage AC motors
- Power systems: switchgear, power transformer, distribution panels
- Material Handling:
- Variable frequency drives for conveyors
- Constant torque control for cranes
- Safety integration for palletizer





# ▶ OUR SHARED VALUES

Our Team comprises of experts & professionals who have a vast experience; having shared values with the following:



MINA ABDULLAH REFINERY, Kuwait – Replacement/Upgrading of Programmable Logic Controllers Project (PHASE-I & II) at Unit 37 (Water Treatment Plant), Unit 74 (Sea Island Shipping & Handling), Unit 50 (Tank Farm)



ELWASTANI, Egypt – Up-gradation of Control System (Phase I, II & III)



Schlumberger, KSA – Surface Control Sub-Surface Hydraulic System for more than 100 Wells



TCO, KAZAKISTAN – Process, Deluge, ESD, F&G Control and Safety Systems For Crude Tank Farm Project Stage-1, Tengiz Reservoir Information Management



OMV, PAKISTAN – Designing and Development of Kadanwari Centralized Upgrade Project, Miano Kadanwari Gas Field (PHASE-I & II) and Miano-11 Well Head



Venice Condensate Stabilizer Complete SCADA System



National Chevron Phillips, Al-Jubail, Saudi Arabia – Front End Engineering and Design (FEED) with Worley Parsons, USA



National Gas Company of Trinidad & Tobago Ltd. – NEO TOBAGO PIPELINE CENTERLIZED SIS/ESD/PCS/FIRE AND GAS CONTROL SYSTEM



Lamberti Chemicals, USA – Replacement/Upgrading of Programmable Logic Controllers and Expansion of New Reactor









**HEAD OFFICE:**

48-G III Johar Town, Lahore, Pakistan.

Tel: +92 423 5290781-82

Fax: +92 423 5290780

**ISLAMABAD OFFICE:**

Sector G-11/3 Block 9-C, Flat # 10,  
Ibn-e-Sina Road, Islambad, Pakistan.

Tel: +92 51 2229194

Fax: +92 51 2229195

**KARACHI OFFICE:**

Plot # 13-E, Office # 03, Mazzanine Floor,  
Sunset Lane Phase II Ext, DHA,  
Karachi Pakistan.

Tel: +92 21 35380050

Fax: +92 21 35380050

**DUBAI OFFICE**

Office # 509-1, Apricot Tower,  
Dubai Silicon Oasis  
United Arab Emirates.

Tel: +971 7333 9317

Fax: +971 4273 1743

[www.powersolutionspk.com](http://www.powersolutionspk.com)

[info@powersolutionspk.com](mailto:info@powersolutionspk.com)

